

hp  
mp3320 series  
digital projector



user's guide

## Notice

The information contained herein is subject to change without notice. The only warranties for HP products and services are set forth in the express warranty statements accompanying such products and services. Nothing herein should be construed as constituting an additional warranty. HP shall not be liable for technical or editorial errors or omissions contained herein.

Consumer transactions in Australia and the United Kingdom: The above disclaimers and limitations shall not apply to consumer transactions in Australia and the United Kingdom and shall not affect the statutory rights of consumers.

© Copyright 2006 Hewlett-Packard Development Company, L.P. Reproduction, adaptation, or translation without prior written permission is prohibited, except as allowed under the copyright laws.

The programs that control this product are copyrighted and all rights are reserved. Reproduction, adaptation, or translation of those programs without prior written permission of Hewlett-Packard Company is also prohibited.

Microsoft® and Windows® are US registered trademarks of Microsoft Corporation. Adobe® and Acrobat® are trademarks of Adobe Systems Incorporated.

Hewlett-Packard Company  
Display Technologies and Products  
1000 NE Circle Blvd.  
Corvallis, OR 97330

First Edition (January 2006)

## 1 Setting Up

|   |    |
|---|----|
| What's in the Box? . . . . .              | 8  |
| Identifying Common Features . . . . .     | 9  |
| Projector at a glance . . . . .           | 10 |
| Projector buttons and lights . . . . .    | 11 |
| Back panel . . . . .                      | 12 |
| Remote control . . . . .                  | 13 |
| Accessories . . . . .                     | 14 |
| Setting Up the Projector . . . . .        | 15 |
| To position the projector . . . . .       | 16 |
| To set up on a table . . . . .            | 17 |
| To connect power . . . . .                | 18 |
| To connect a computer . . . . .           | 19 |
| To connect a handheld organizer . . . . . | 20 |
| To connect video sources . . . . .        | 21 |
| Turning On and Off . . . . .              | 24 |
| To turn the projector on . . . . .        | 24 |
| To turn the projector off . . . . .       | 25 |
| Making Basic Adjustments . . . . .        | 26 |
| To aim the projector . . . . .            | 26 |
| To adjust the focus and zoom . . . . .    | 27 |

## 2 Giving Presentations

|                                       |    |
|---------------------------------------|----|
| Using the Remote Control . . . . .    | 29 |
| Showing Presentations . . . . .       | 31 |
| To present from a computer . . . . .  | 31 |
| To change the source . . . . .        | 32 |
| To hide or show the display . . . . . | 32 |

### 3 Adjusting the Projector

|  |    |
|--|----|
| Adjusting the Picture and Sound . . . . .                      | 33 |
| To adjust a slanted picture. . . . .                           | 33 |
| To adjust the image according to the type of picture . . . . . | 34 |
| To adjust other image settings. . . . .                        | 34 |
| To adjust the audio . . . . .                                  | 34 |
| To adjust the projector setup . . . . .                        | 35 |
| Using the On-Screen Menu . . . . .                             | 36 |
| To change settings using the on-screen menu . . . . .          | 37 |
| Quick choice menu . . . . .                                    | 38 |
| Select input menu . . . . .                                    | 39 |
| Adjust picture menu . . . . .                                  | 40 |
| Setup menu . . . . .   | 42 |
| Help menu . . . . .  | 42 |

### 4 Maintaining the Projector

|  |    |
|--|----|
| Performing Routine Maintenance . . . . .               | 43 |
| To get the projector status . . . . .                  | 43 |
| To clean the projector lens . . . . .                  | 44 |
| To replace the lamp module . . . . .                   | 44 |
| To replace the battery in the remote control . . . . . | 46 |
| Upgrading the Projector. . . . .                       | 47 |
| To update the firmware . . . . .                       | 47 |

### 5 Installing Permanently

|  |    |
|--|----|
| Installing the Projector . . . . .           | 49 |
| To install on a table . . . . .              | 49 |
| To install on the ceiling. . . . .           | 50 |
| To install for rear projection . . . . .     | 52 |
| To mount the projector on a tripod . . . . . | 53 |
| To lock the projector . . . . .              | 53 |

## 6 Fixing Problems

|  |    |
|--|----|
| Troubleshooting Suggestions . . . . .      | 55 |
| Start-up problems . . . . .                | 56 |
| Picture problems . . . . .                 | 57 |
| Sound problems . . . . .                   | 61 |
| Interruption problems . . . . .            | 61 |
| Remote control problems . . . . .          | 62 |
| Testing the Projector . . . . .            | 63 |
| To run the projector diagnostics . . . . . | 63 |

## 7 Reference

|                                  |    |
|----------------------------------|----|
| Specifications . . . . .         | 65 |
| Safety Information . . . . .     | 70 |
| Safety precautions . . . . .     | 70 |
| LED safety . . . . .             | 71 |
| Mercury safety . . . . .         | 71 |
| Regulatory Information . . . . . | 72 |
| U.S.A. . . . .                   | 72 |
| Canada . . . . .                 | 72 |
| Japan . . . . .                  | 73 |
| Korea . . . . .                  | 73 |
| International . . . . .          | 74 |

## Index



The chapter explains how to install and set up the HP digital projector.

- “What’s in the Box?” on page 8
- “Identifying Common Features” on page 9
- “Setting Up the Projector” on page 15
- “Turning On and Off” on page 24
- “Making Basic Adjustments” on page 26

## What's in the Box?

Before setting up your projector, be sure your shipping box includes the following items. If the shipping box does not contain any of the following items, contact HP.



### Identifying the contents of the box

| Symbol | Item  | Function  |
|--------|---|---|
| ①      | Projector   | Displays images.  |
| ②      | Carrying case   | Carries and protects projector.                             |
| ③      | USB cable   | Connects to computer USB input.                             |
| ④      | VGA cable   | Connects to computer video output.                          |
| ⑤      | Remote control  | Control projector.  |
| ⑥      | <i>Quick Setup Guide</i> , warranty, support, and port activation documentation | Provide documentation to help get started and find support. |
| ⑦      | Documentation CD  | Contains user's guide and other documentation.              |
| ⑧      | Power cord  | Connects projector to power source.                         |

Appearance of included remote may vary from remote shown. Functionality is the same.



## Identifying Common Features

This section identifies common features and functions of the projector.

- “Projector at a glance” on page 10
- “Projector buttons and lights” on page 11
- “Back panel” on page 12
- “Remote control” on page 13
- “Accessories” on page 14

## Projector at a glance

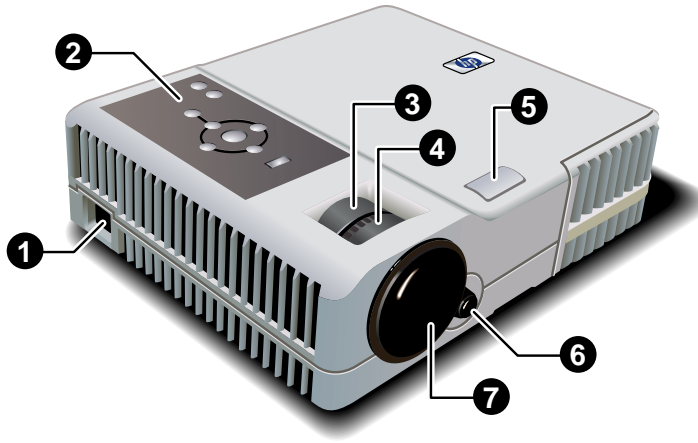

### Identifying the projector

| Symbol | Item                        | Function  |
|--------|-----------------------------|---|
| ❶      | Power cord socket           | Connects power cord to projector.                 |
| ❷      | Button panel                | Contains buttons and lights.                      |
| ❸      | Zoom ring                   | Enlarges picture size 100–120%.                   |
| ❹      | Focus ring                  | Focuses at distances of 1.2 to 12 m (4 to 40 ft). |
| ❺      | Height adjustment button    | Adjusts the height of the picture.                |
| ❻      | Receiver for remote control | Receives signals from the remote control.         |
| ❼      | Lens cover                  | Protects lens.                                    |

## Projector buttons and lights

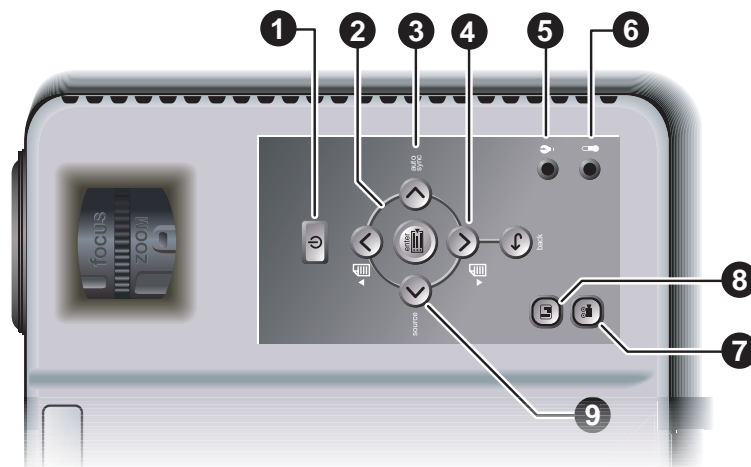

### Identifying buttons and lights on the projector

| Symbol | Item  | Function  |
|--------|---|---|
| ❶      | Power button                                      | Turns the projector on or off.                            |
| ❷      | Enter button, back button, and directional arrows | Change projector settings using the on-screen menu.       |
| ❸      | Auto sync button                                  | Resynchronizes the projector to the input signal.         |
| ❹      | Page-up and page-down buttons                     | Scroll up and down through pages on a connected computer. |
| ❺      | Lamp-warning light                                | Turns on when lamp fails.                                 |
| ❻      | Temperature-warning light                         | Turns on when the internal temperature is too high.       |
| ❼      | Video button                                      | Optimizes the picture for video input.                    |
| ❽      | Graphics button                                   | Optimizes the picture for data input.                     |
| ❾      | Source button                                     | Switches to the next input source.                        |

## Back panel

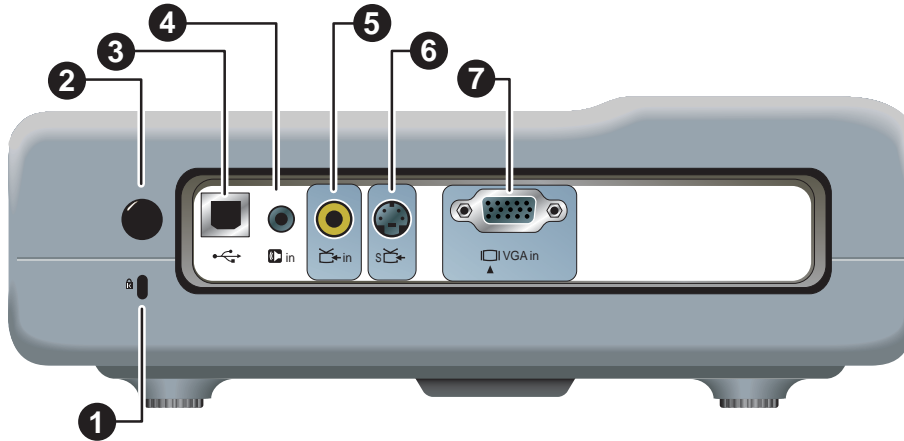

### Identifying the back panel

| Symbol | Item                        | Function   |
|--------|-----------------------------|--|
| ①      | Security slot               | Secures the projector using a cable lock.                    |
| ②      | Receiver for remote control | Receives signals from the remote control.                    |
| ③      | USB output                  | Connects to computer to control the mouse.                   |
| ④      | Audio input                 | Connects audio source.                                       |
| ⑤      | Composite-video input (RCA) | Connects video input from devices like VCRs.                 |
| ⑥      | S-video input               | Connects video input from devices like VCRs and DVD players. |
| ⑦      | VGA input                   | Connects video input from computers.                         |

## Remote control



Before using the remote control, remove the battery protector by pulling the plastic tab until it comes out of the remote control.

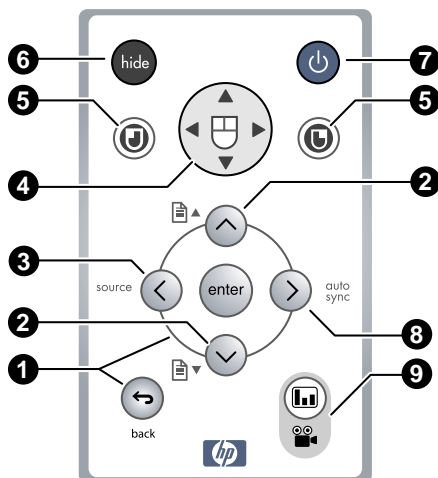

### Identifying the remote control buttons

| Symbol | Item  | Function   |
|--------|---|--|
| ❶      | Enter button, back button, and directional arrows | Change projector settings using the on-screen menu.                          |
| ❷      | Page-up and page-down buttons                     | Scroll up and down through pages on a connected computer.                    |
| ❸      | Source button                                     | Switches to the next input source.   |
| ❹      | Mouse pad   | Moves the mouse pointer on a connected computer.                             |
| ❺      | Left-click and right-click mouse buttons          | Perform left-click and right-click mouse functions for a connected computer. |
| ❻      | Hide button                                       | Hides the display.   |
| ❼      | Power button                                      | Turns the projector on or off.   |
| ❽      | Auto sync button                                  | Resynchronizes the projector to the input signal.                            |
| ❾      | Picture mode button                               | Adjusts the picture so it is optimized for either video input or data input. |

## Accessories

Get more from your presentations with HP projector accessories. You can purchase accessories at [www.hp.com](http://www.hp.com) or through your projector dealer.

- **HP ceiling mount kit** enables you to simply and discreetly install your projector on the ceiling.
- **HP mobile screens** with built-in handles are easy to carry and set up anywhere you need them.
- **HP premium remote control** allows you to control every aspect of your presentation.
- **HP power cables** allow you to connect in any region.
- **HP cables** allow you to connect all audio-video equipment.
- **HP replacement lamp** brings your projector up to factory-fresh brightness.

## Setting Up the Projector

This section describes how to set up, plan, and connect the projector.

- “To position the projector” on page 16
- “To set up on a table” on page 17
- “To connect power” on page 18
- “To connect a computer” on page 19
- “To connect a handheld organizer” on page 20
- “To connect video sources” on page 21

## To position the projector

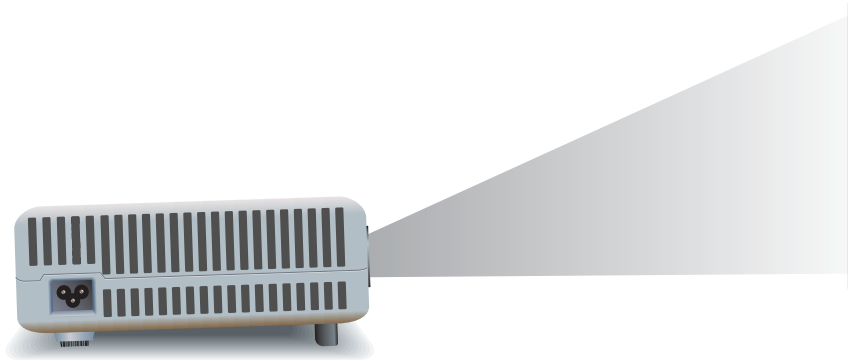

The following tables show you where to position the projector in relation to the screen.

### Identifying image size relative to distance from screen

| Image size (diagonal) |       | Image size (width) |       | Distance (lens to screen) |             |
|-----------------------|-------|--------------------|-------|---------------------------|-------------|
| 30 in.                | 0.8 m | 24 in.             | 0.6 m | 48–58 in.                 | 1.2–1.5 m   |
| 40 in.                | 1.0 m | 32 in.             | 0.8 m | 64–77 in.                 | 1.6–2.0 m   |
| 60 in.                | 1.5 m | 48 in.             | 1.2 m | 96–115 in.                | 2.4–2.9 m   |
| 80 in.                | 2.0 m | 64 in.             | 1.6 m | 128–154 in.               | 3.3–3.9 m   |
| 100 in.               | 2.5 m | 80 in.             | 2.0 m | 160–192 in.               | 4.1–4.9 m   |
| 120 in.               | 3.0 m | 96 in.             | 2.4 m | 192–230 in.               | 4.9–5.9 m   |
| 150 in.               | 3.8 m | 120 in.            | 3.0 m | 240–288 in.               | 6.1–7.3 m   |
| 180 in.               | 4.6 m | 144 in.            | 3.7 m | 288–346 in.               | 7.3–8.8 m   |
| 200 in.               | 5.1 m | 160 in.            | 4.1 m | 320–384 in.               | 8.1–9.8 m   |
| 240 in.               | 6.1 m | 192 in.            | 4.9 m | 384–461 in.               | 9.8–11.7 m  |
| 270 in.               | 6.9 m | 216 in.            | 5.5 m | 432–480 in.               | 11.0–12.0 m |
| 290 in.               | 7.4 m | 232 in.            | 5.9 m | 464–480 in.               | 11.8–12.0 m |



If you do not want to use the distance table, you can use the following equations to help determine where to install the projector relative to the screen.

### Calculating projection dimensions

---

distance from lens to screen =  $A \times$  width of screen

minimum and maximum distance from screen =  $B$

width of screen =  $0.8 \times$  diagonal of screen (for 4:3 screen)

projector lens below bottom of screen =  $C \times$  width of screen (for 4:3 screen)

---

$A = 2.0$  to  $2.4$

$B = 1.2$  to  $12$  m (4 to 40 ft)

$C = 0.11$  to  $0.42$

---

### To set up on a table

1. Place the projector on a stable platform located 1.2 to 12 m (4 to 40 ft) in front of the screen. Ideally, the platform should be lower than the bottom of the screen.
2. Connect one end of the power cord to the side of the projector and the other end to an electrical outlet.
3. When you first turn on the projector, if the image is upside-down or backward, you should change a menu setting. Open the on-screen menu (see “To change settings using the on-screen menu” on page 37) and select **Setup > Projector position**. Then choose **Front Table** from the drop-down list—this is the default setting.

If you want to permanently install the projector on the ceiling or behind the screen, see “Installing the Projector” on page 49.

## To connect power

- Connect one end of the power cord to the side of the projector **①** and the other end to an electrical outlet **②**.



## To connect a computer

1. Connect the VGA cable between the VGA port on the projector **1** and the VGA port on the computer **2**.
2. (Optional) To allow the remote control to function as the computer mouse, connect the USB cable between the USB port on the projector **3** and the USB port on the computer **4**.
3. (Optional) To get audio, connect a mini-phone audio cable (not provided) between the audio port on the projector **5** and the computer **6**.

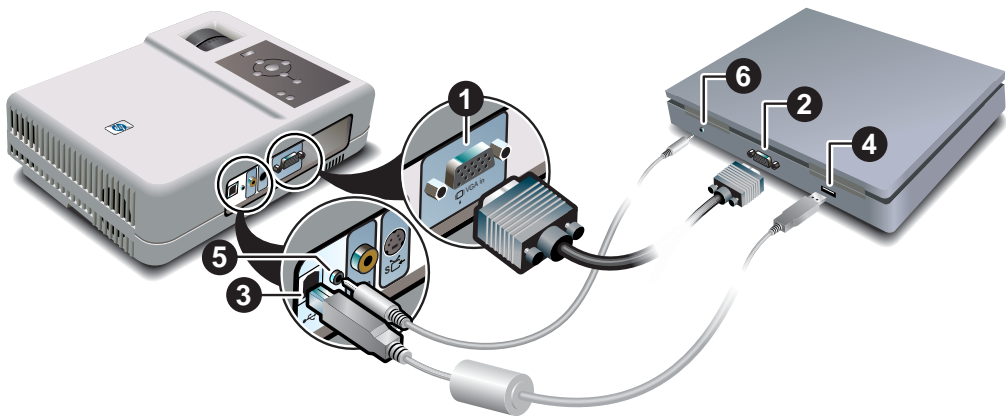

## To connect a handheld organizer

1. Be sure the handheld organizer has a VGA-out port. If necessary, install a VGA-out accessory card into the organizer.



---

Not all handhelds come with VGA-out ports. For example, the iPAQ Pocket PC requires a VGA-out PC Card with 15-pin connector.

---

2. Connect the VGA cable between the VGA port on the projector **1** and the VGA-out PC Card **2** on the organizer.

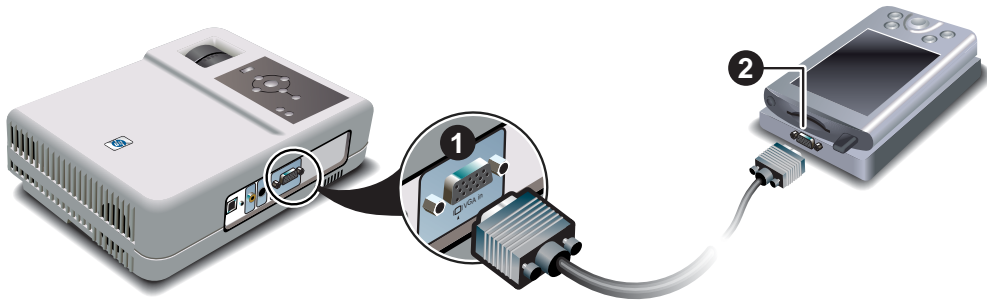

## To connect video sources

If you have a SCART video device, you will need an adapter (available from HP) to connect the device to the projector.

### S-video connection

Many DVD players and VCRs have S-video output.

1. Connect an S-video cable (not provided) between the S-video port on the projector **1** and the video device **2**.
2. (Optional) To get audio, connect a mini-phone audio cable (not provided) between the audio port on the projector **3** and the video device **4**. If the video device has RCA audio connectors, use a mini-phone to RCA adapter or cable.

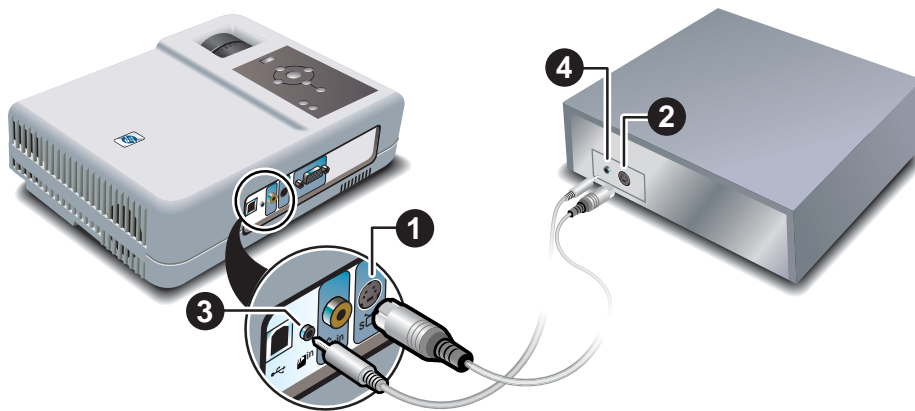

### Composite video connection

Many VCRs and other video equipment have composite video output, a single RCA video output connector.

1. Connect a composite video cable (RCA connector) (not provided) between the composite video port on the projector **1** and the RCA video port on the video device **2**.
2. (Optional) To get audio, connect a mini-phone audio cable (not provided) between the audio port on the projector **3** and the video device **4**. If the video device has RCA audio connectors, use a mini-phone to RCA adapter or cable.

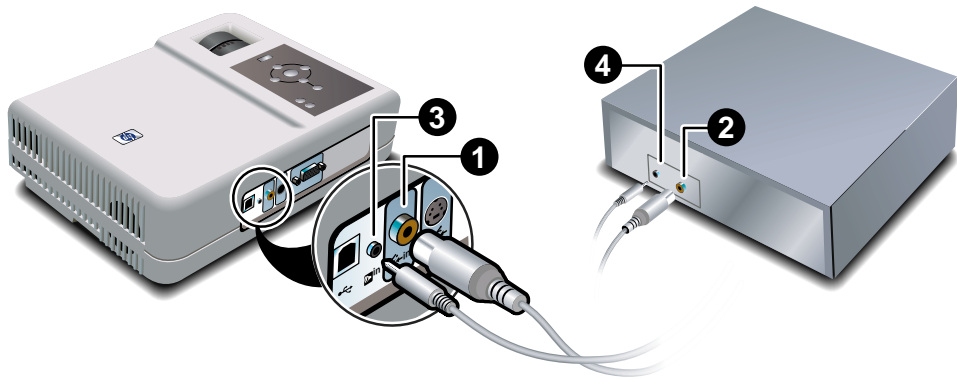

## Component video connection

Many DVD players and other video equipment have component-video output, three RCA connectors labeled "Y,Pb,Pr", "R,G,B", or similar.

1. Connect a VGA-to-component video cable (available from HP) between the VGA port on the projector **1** and the three RCA component-video connectors on the video device **2**.
2. (Optional) To get audio, connect a mini-phone audio cable (not provided) between the audio port on the projector **3** and the video device **4**. If the video device has RCA audio connectors, use a mini-phone to RCA adapter or cable.

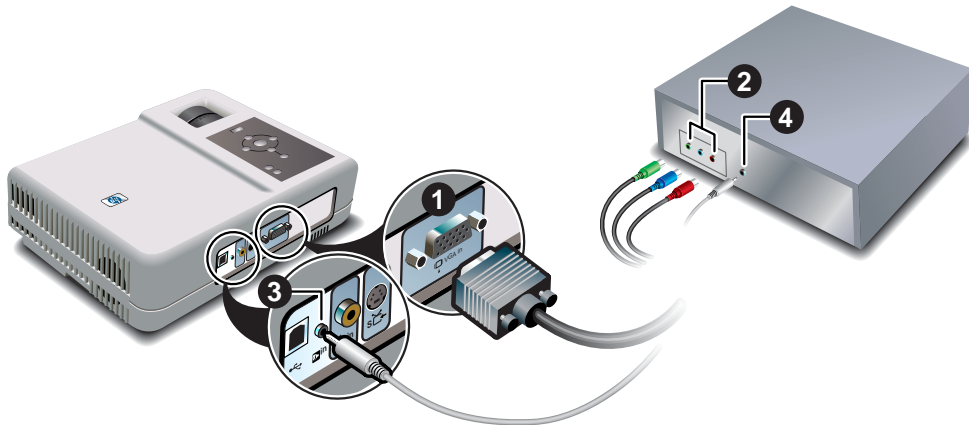

## Turning On and Off

This section provides instructions on turning the projector on and off.

- “To turn the projector on” on page 24
- “To turn the projector off” on page 25

### To turn the projector on

1. Be sure the power cord is connected.
2. Open the lens cover **1** by rotating it.
3. Press the power button **2** on top of the projector, or press the power button on the remote control.

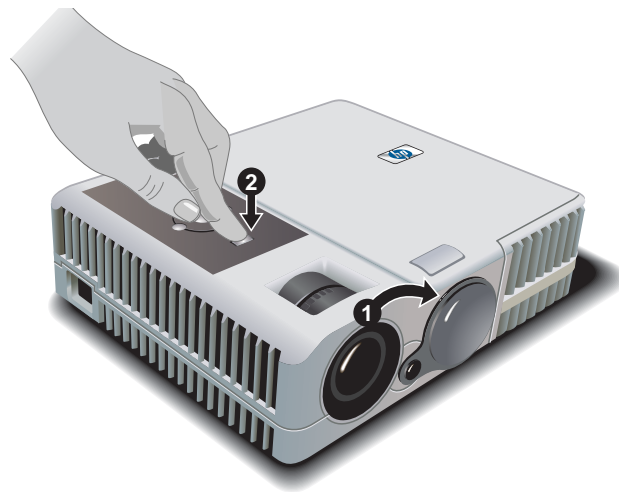

4. Connect and power on the source, such as computer, handheld organizer, or DVD player. See “Setting Up the Projector” on page 15 for more information.



## To turn the projector off

1. Press the power button on the projector or remote control to turn off the projector. The power button blinks during the cool-down period, then the projector turns off.
2. You can disconnect video and audio equipment from the projector during the cool-down period, but not the power cord.
3. If you must unplug or remove the projector, wait until the power light stops blinking, then unplug the power cord.



**CAUTION:** Do *not* disconnect power until the projector has cooled down (the fan stops) and the power button stops blinking. Otherwise, you might shorten the life of the lamp.

---

If you try to turn on the projector again during the cool-down period, it does not turn on. Wait until the cool-down period ends and the power button stops blinking.

## Making Basic Adjustments

This section provides instructions on making basic adjustments to the projector.

- “To aim the projector” on page 26
- “To adjust the focus and zoom” on page 27

### To aim the projector

- To raise the projected picture on the screen, press the height adjustment button ❶ and lift the front of the projector to the desired display angle ❷. Release the button to lock the adjustment.
- To lower the projected picture, press the height adjustment button while lowering the front of the projector. Release the button to lock the adjustment.
- To store the projector, press the height adjustment button and lower the projector fully, then release the button.

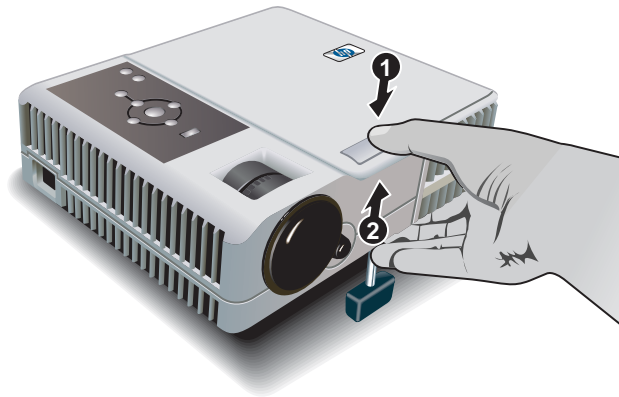

When you tilt the projector up or down, the sides of the picture might become slanted. To adjust the picture so the sides are vertical, see “To adjust a slanted picture” on page 33.

If the picture is not level on the screen, screw the adjustable back foot in or out to level the projector.

## To adjust the focus and zoom

1. Rotate the focus ring until the image becomes clear. The projector can be focused at distances of 1.2 to 12 m (4 to 40 ft).
2. Rotate the zoom ring to adjust the picture size from 100 to 120%.



If the picture does not fit the screen, you might have to move the projector closer to the screen.



---

## Giving Presentations







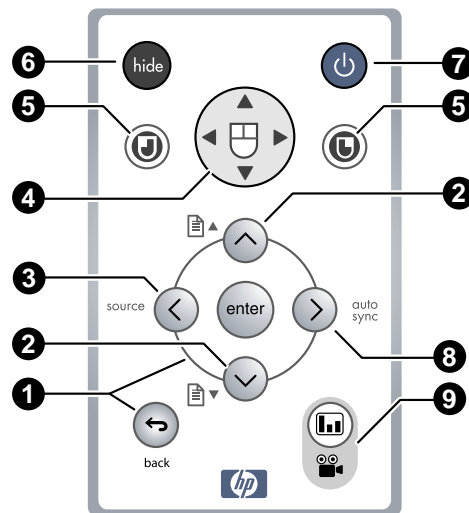

The chapter explains how to give presentations with the projector.

- “Using the Remote Control” on page 29
- “Showing Presentations” on page 31

### Using the Remote Control



- To turn the projector on or off, press the power button 7.
- To hide or unhide the projected picture, press the **hide** button 6.
- To switch to the next connected input source, press the **source** button 3.

- To operate as a mouse on a computer, press the edge of the mouse pad  in the direction you want the pointer to move, and press the left-click  or right-click  button. This feature requires a USB connection between the projector and computer.
- To control page-up and page-down on a computer, press the page-up  and page-down  buttons . This feature requires a USB connection between the projector and computer.
- To optimize the picture for the type of input signal, press the picture mode /  button. This changes between adjustments for video input and for data input.
- To change projector settings using the on-screen menu, press **enter** and use the navigation buttons to make the changes. See “Using the On-Screen Menu” on page 36 for more details.
- To exit from any on-screen menu or adjustment, press the **back**  button.
- To adjust synchronization, press the **auto sync** button.



From within a distance of 9 m (30 ft), aim the remote control at the screen or at the front or back of the projector.

---

## Showing Presentations

This section describes several things you can do during presentations.



- “To present from a computer” on page 31
- “To change the source” on page 32
- “To hide or show the display” on page 32

### To present from a computer



1. Be sure the computer is connected to the projector. See “To connect a computer” on page 19 for more information.
2. Be sure the computer and the projector are on. See “To turn the projector on” on page 24 for more information.



If the computer display is not projected on the screen, you might have to press a function key (such as **Fn + F4** or **Fn + F5**) to turn on the computer’s video port. See the video port card shipped with the projector for more information.

3. If you want to adjust the projected image, see “Adjusting the Picture and Sound” on page 33.
4. You can use the remote control to enhance your presentation. For more information, see “Using the Remote Control” on page 29.
  - ❑ To page through a presentation, press the page-up ▲ or page-down ▼ buttons.
  - ❑ To move the mouse pointer, press the edge of the mouse pad in the direction you want the pointer to move.



For the mouse and page-up ▲ or page-down ▼ operations, aim the remote control at the screen or at the front or back of the projector from within a distance of 9 m (30 ft).

These operations require a USB connection from the projector to the computer.

## To change the source

To change the source, either:

- Press the **source** button on the projector or remote control.
- Open the on-screen menu, go to **Select input** and select the port to which the input source is connected.

## To hide or show the display

You can hide the display from your audience temporarily.

- Press the **hide** button on the remote control. (If you press the **hide** button again within 5 seconds, the display becomes completely blank, without the reminder how to show the display again.)
- Open the on-screen menu and select **Quick choice > Hide**.

The screen remains blank until you press the **hide** button again or any other button on the projector or remote control.



If you are using Microsoft PowerPoint, you can also press the **B** key or the **W** key to hide the display. The screen remains blank until you press the **B** key or the **W** key again.

---



---

## Adjusting the Projector

This chapter describes how to make adjustments to the projector.

- “Adjusting the Picture and Sound” on page 33
- “Using the On-Screen Menu” on page 36

### Adjusting the Picture and Sound

This section provides the following instructions on adjusting the picture and sound.

- “To adjust a slanted picture” on page 33
- “To adjust the image according to the type of picture” on page 34
- “To adjust other image settings” on page 34
- “To adjust the audio” on page 34
- “To adjust the projector setup” on page 35





#### To adjust a slanted picture

If the picture has slanted sides on the screen, you can straighten them. This is done by making the top or bottom *shorter* until the sides are straight.

1. Open the on-screen menu and select **Quick choice > Keystone**.
2. Adjust the keystone setting as needed using the menu buttons on the projector or remote control:
  - If the top of the picture is too wide or too narrow, press left **<** or right **>** until the width is corrected.
  - If one side of the picture is too tall or too short, move the projector until it is straight in front of the screen, not off to one side.
3. Press the **back** **↩** button to save the settings.

## To adjust the image according to the type of picture

Use the picture mode buttons on the projector or the remote control to optimize the image.

- To optimize the picture for data presentations, press the graphics  button on the projector.  
The graphics button turns on.
- To optimize the picture for video images, press the video  button on the projector.  
The video button turns on.
- To switch between these settings, press the picture mode  /  button on the remote control.

## To adjust other image settings

The on-screen menu provides many settings that allow you to fine-tune the picture.

1. Open the on-screen menu and select **Adjust picture**.
2. Change the picture adjustments as needed.

From the Adjust picture menu, you can change basic and advanced picture options, such as brightness, contrast, aspect ratio, and keystone correction.

To get descriptions for all available picture adjustments, see “Adjust picture menu” on page 40.



To exit from any on-screen menu or adjustment, press the **back**  button.

---

## To adjust the audio

1. Open the on-screen menu and select **Quick choice**.
2. Set the audio adjustments.

From the Quick choice menu, you can adjust mute and volume.

## To adjust the projector setup

1. Open the on-screen menu and select **Setup**.
2. Set the setup adjustments as needed.

From the Setup menu, you can select settings such as menu language, projector position, and lamp saver mode.

To get descriptions for all available setup adjustments, see “Setup menu” on page 42.

## Using the On-Screen Menu

This section explains how to navigate the on-screen menu and provides function definitions. The tables in this section describe all the functions available in the on-screen menu for the firmware version at publication. If your firmware is a different version, some menus might differ from those shown.

- “To change settings using the on-screen menu” on page 37
- “Quick choice menu” on page 38
- “Select input menu” on page 39
- “Adjust picture menu” on page 40
- “Setup menu” on page 42
- “Help menu” on page 42



To exit from any on-screen menu or adjustment, press the **back**  button.

---

## To change settings using the on-screen menu

You can change the on-screen menu settings with either the buttons on the projector or on the remote control.

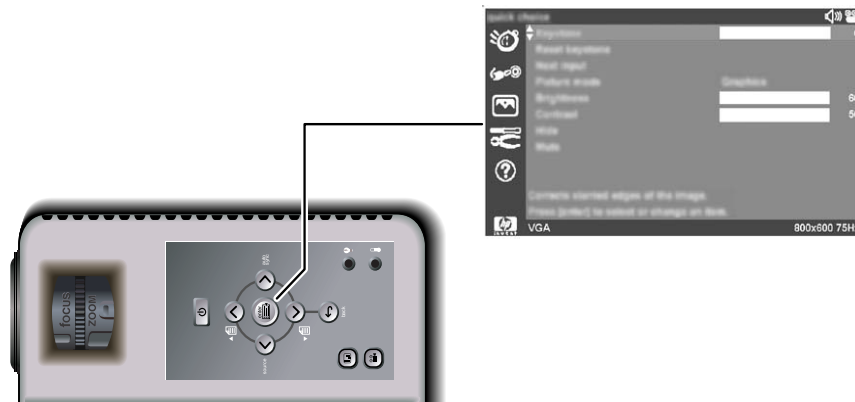

1. Press **enter** on the projector or the remote control to open the on-screen menu.
2. Press up **▲** or down **▼** to highlight the desired menu, and press right **▶** to select the highlighted menu.
3. Press up **▲** or down **▼** to highlight the desired parameter, and press **enter** to select the highlighted option.
4. Press left **◀** or right **▶** to select the desired setting. For certain settings, you see a different display while making the change.
5. Press **enter** or other indicated button to return to the menu.
6. To go to a different menu, press left **◀** and select the menu.
7. To close the on-screen menu, press the **back** **↶** button.

If nothing occurs for a period of time, the on-screen menu closes. To change the amount of time until the on-screen menu closes, open the on-screen menu and select **Setup > Timeout for menu**.



When you make certain adjustments, you may want to change several related settings. If a setting adjustment includes a hint for moving to related settings, you can press up **▲** or down **▼** to quickly move to another setting and adjust it.

## Quick choice menu

### Quick choice

|                |  |
|----------------|--|
| Keystone       | Corrects the slanted sides of an image.  |
| Reset keystone | Resets keystone correction to zero.  |
| Next input     | Searches for the next available signal from an input source.   |
| Picture mode   | Adjusts the color settings for the type of picture. You can optimize the picture for computer presentations or video output. The remote control and projector have buttons to change the picture mode. |
| Brightness     | Brightens or darkens the image.  |
| Contrast       | Sets difference between light and dark areas.  |
| Hide           | Removes all images from the screen.  |
| Mute           | Stops audio output.  |
| Volume         | Adjusts the volume.  |

---

## Select input menu

For a visual aid, see “Back panel” on page 12.

### Select input

|                   |  |
|-------------------|--|
| VGA               | Shows the input to the VGA port. This usually connects to a computer, although it can also connect to a component-video device. This input is normally considered a graphics input.                    |
| Composite video   | Shows the input to the yellow composite port (the input to the left of the S-video port on the back panel). The port usually connects to a TV or VCR. This input is normally considered a video input. |
| S-video           | Shows the input to the S-video port. This usually connects to a video device, such as a VCR, camcorder, or DVD player. This connection is normally considered a video input.                           |
| Auto-scan sources | Sets whether the projector automatically searches for input signals and displays the next one found.   |

---

## Adjust picture menu

### Adjust picture

|                         |   |
|-------------------------|---|
| Picture mode            | Adjusts the color settings for the type of picture. You can optimize the picture for computer presentations or video output. The remote control and projector have buttons to change the picture mode.  |
| Adjust picture mode...  | Changes settings that define the current picture mode.  |
| White intensity         | Sets the brightness of white areas.   |
| Picture enhancement     | Refines the color, lightness, and other characteristics of the picture.   |
| Color temperature       | Shifts colors toward red or blue.   |
| Aspect ratio            | <p>Selects the proportions of the image that is not automatically corrected by the projector.</p> <ul style="list-style-type: none"> <li>• To automatically adapt to most inputs, select <b>Best Fit</b>.</li> <li>• To stretch the picture to cover the entire projection area, select <b>Fill</b>.</li> <li>• To show each picture dot as one projected dot, select <b>1-to-1</b>.</li> </ul> <p>If the input source is a widescreen device, go to <b>Adjust picture &gt; Shape settings &gt; Widescreen input</b>.</p> |
| Reset this picture mode | Resets the current picture mode to its default settings.  |
| Color settings...       | Adjusts the picture and colors.   |
| Brightness              | Brightens or darkens the image.   |
| Contrast                | Sets the difference between light and dark areas.   |
| Sharpness               | Sharpens or softens the image.  |
| Color saturation        | Adjusts the intensity of colors.  |



**Adjust picture** *(continued)*

|                      |   |
|----------------------|---|
| Tint                 | Shifts colors toward red or green.  |
| Red                  | Adjusts the amount of red in the picture.   |
| Green                | Adjusts the amount of green in the picture.   |
| Blue                 | Adjusts the amount of blue in the picture.  |
| Color space          | For certain component inputs, selects the type of signal encoding used by the input source. You can override the selection made by the projector. |
| Reset color settings | Resets these color settings to their default settings.  |
| Shape settings...    | Adjusts the shape of the picture.   |
| Keystone             | Corrects the slanted sides of an image.   |
| Reset keystone       | Resets keystone correction to zero.   |
| Widescreen input     | Sets whether a widescreen (16:9) input device is in use.  |
| VGA settings...      | Adjusts settings for the VGA input port.  |
| Auto-sync            | Resynchronizes the projector to the input signal from a computer. This can compensate for any change in the signal.                               |
| Frequency            | Adjusts the timing of the projector relative to a computer graphics card.   |
| Tracking             | Synchronizes the projector to a computer graphics card.   |
| Vertical offset      | Shifts the image up or down within the projection area.   |
| Horizontal offset    | Shifts the image left or right within the projection area.  |
| Reset video settings | Resets all video settings to default settings.  |

## Setup menu

### Setup

|                    |   |
|--------------------|---|
| Language...        | Selects the language for the menus.   |
| Lamp saver         | Sets a lower power level for the lamp.  |
| Projector position | Adjusts the image to match the orientation of the projector: upright or upside-down, in front of or behind the screen. Inverts or reverses the image accordingly. |
| Timeout for menu   | Sets how many seconds the on-screen menu waits for input before it closes.  |
| Auto-scan sources  | Sets whether the projector automatically searches for input signals and displays the next one found.  |
| Reset lamp hours   | For a new lamp, resets hours of use.  |
| Reset all settings | Resets all menu settings to default settings.   |

## Help menu

### Help

|                |  |
|----------------|--|
|                | Displays information and status for the projector.                             |
| Diagnostics... | Show tests for checking the operation of the projector and the remote control. |

---

## Maintaining the Projector

This chapter explains how to maintain the projector.

- “Performing Routine Maintenance” on page 43
- “Upgrading the Projector” on page 47

### Performing Routine Maintenance

This section provides instructions on performing routing maintenance.

- “To get the projector status” on page 43
- “To clean the projector lens” on page 44
- “To replace the lamp module” on page 44
- “To replace the battery in the remote control” on page 46

#### To get the projector status

- Open the on-screen menu and select **Help**. This screen shows information and status for the projector.

## To clean the projector lens

- To minimize the risk of damaging or scratching the lens surface, blow dust particles off the lens with clean, dry, deionized air.

If this method does not work, use the following method:

- Wipe the lens in a single direction with a clean, dry cloth. Do not wipe back and forth across the lens.

If the cloth is dirty or smears the lens, wash the cloth. If the cloth is still dirty after washing it or the fabric is damaged, replace it.



**CAUTION:** Cleaning requires special consideration:

- Do not spray any type of fluid or cleaner directly on the lens surface. Cleaners might damage the lens.
  - Do not use fabric softener when washing a cleaning cloth or softener sheets when drying the cloth. Chemicals on the cloth might damage the surface of the lens.
  - Do not store a cleaning cloth in contact with the lens for a long time because doing so contaminates the lens with dye from the cloth. The cloth can be contaminated if left in the open air.
- 

## To replace the lamp module



**WARNING:** Replacing the lamp module requires special consideration:

- To reduce the risk of injury, be careful when removing the lamp module as broken glass might be present in the unlikely event the lamp is broken. If the lamp is broken, contact HP about repairs that might be required.
  - The lamp contains a small amount of mercury. If the lamp breaks, adequately ventilate the area where the breakage occurred. Disposal of this lamp might be regulated due to environmental considerations. For disposal or recycling information, contact your local authorities or the Electronic Industries Alliance (<http://www.eiae.org>).
  - Because the lamp assembly operates at a very high temperature, wait 30 minutes before removing the lamp module.
-

1. Turn off the projector and allow it to cool for 30 minutes.
2. On the bottom of the projector, loosen the two screws on the lamp cover and remove the cover.
3. Loosen the two screws on the lamp module and pull out the module.
4. Insert the lamp module and tighten the two screws.
5. Install the cover and tighten the two screws.
6. Turn on the projector. If the lamp does not turn on after the warm-up period, try reinstalling the lamp again.
7. Open the on-screen menu and select **Setup > Reset lamp hours**.

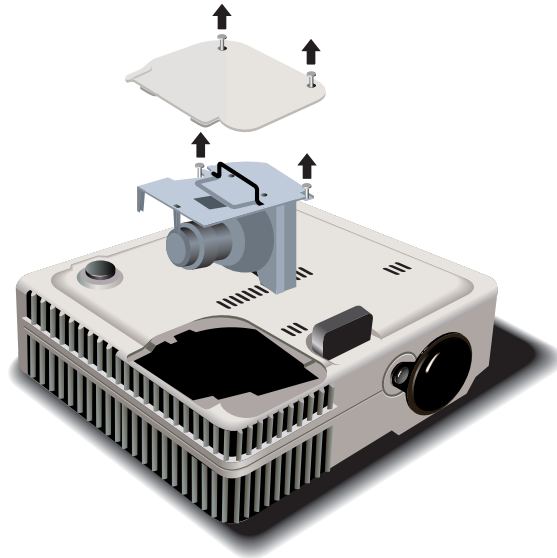

## To replace the battery in the remote control

1. Pull out the battery holder.
2. Insert the new battery in the holder.
3. Push the holder into the remote control.

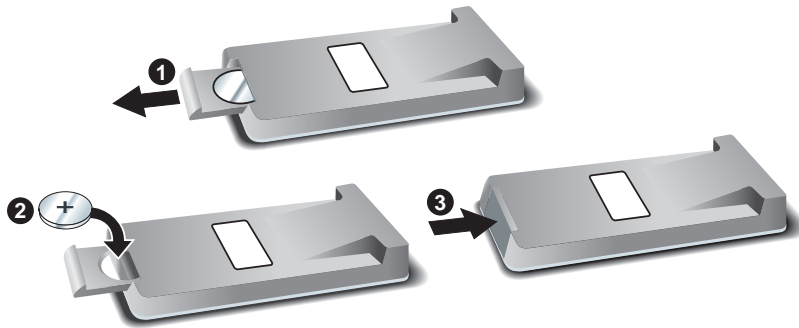

When discarding old batteries, contact your local waste-disposal provider regarding local restrictions on the disposal or recycling of batteries.



## Upgrading the Projector

### To update the firmware

HP might periodically release updated versions of the projector firmware to enhance the projector performance. The projector firmware version is shown in the on-screen menu at **Help**. Also, additional language support is available by firmware download. Check for different versions at <http://www.hp.com/support>.

#### **USB method**

1. On a computer with a USB port, go to the HP projector upgrade website (see introduction for this section) and download the latest file intended for a USB upgrade.
2. Connect the USB cable between the USB port on the projector and the USB port on the computer.
3. On the computer, run the file you downloaded by double-clicking the file. Follow the on-screen instructions.





---

## Installing Permanently

This chapter explains how to permanently install the digital projector.

### Installing the Projector

This section provides instructions on how to permanently install the projector.

- “To install on a table” on page 49
- “To install on the ceiling” on page 50
- “To install for rear projection” on page 52
- “To mount the projector on a tripod” on page 53
- “To lock the projector” on page 53

#### To install on a table

This installation is covered in detail in Chapter 1. See “Setting Up the Projector” on page 15 for more information.

## To install on the ceiling

To install the projector on a ceiling, you will need a ceiling mount (available from HP).



**WARNING:** To minimize the risk of injury from improperly installed equipment, it is recommended that a professional installer performs the ceiling installation.

---



The actual projector and mounting plate differ from those shown below, but the steps are the same.

---

1. Attach the mounting plate to the bottom of the projector. The pointed part of the hole in the bracket faces the back of the projector. See the instructions that came with the ceiling mount.

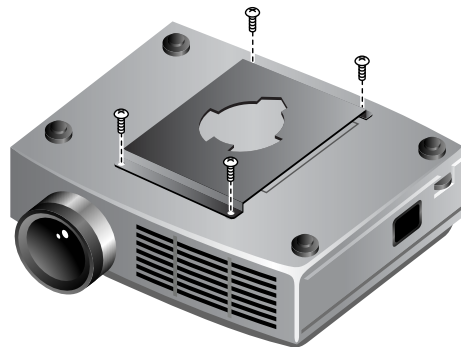

2. Attach the ceiling-mount bracket to the ceiling, and firmly secure with three or four screws capable of holding 9 kg (20 lb). The ceiling-mount bracket must be located 1.2 to 12 m (4 to 40 ft) in front of the screen. See the table in “Setting Up the Projector” on page 15.

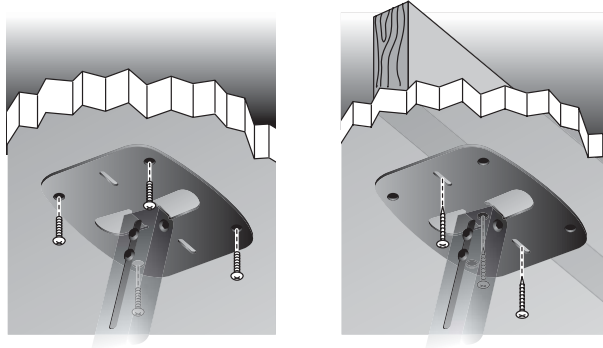

3. With the projector lens aiming away from the screen, insert the mounting plate onto the bracket so the tabs engage, then pivot the projector so it aims forward. Tighten the rear thumbscrew fully, then tighten the two other thumbscrews.



4. Adjust the on-screen menu to match your settings. Open the on-screen menu and select **Setup > Projector position**. Then select **Front Ceiling** from the drop-down list.

If you do not use an HP ceiling mount, mount the projector according to the following dimensions:

- X = 82 mm (3.23 in.)
- Y = 55 mm (2.17 in.)
- Z = 110 mm (4.33 in.)
- Thread size = M3

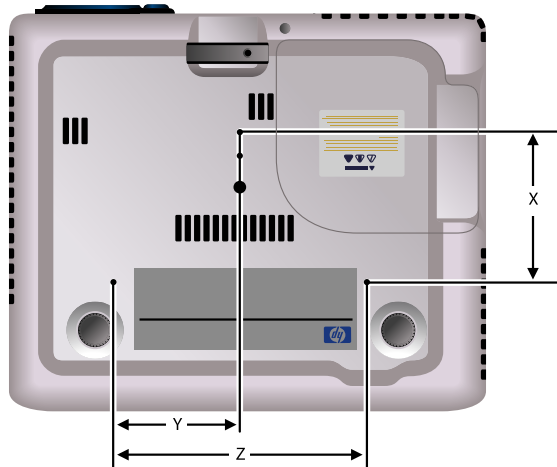

## To install for rear projection

1. Place the projector 1.2 to 12 m (4 to 40 ft) behind a translucent screen that is designed for rear projection.  
  
See “To set up on a table” on page 17 or “To install on the ceiling” on page 50 for more instructions.
2. Open the on-screen menu and select **Setup > Projector position**. Then select **Rear Table** or **Rear Ceiling** from the drop-down list.

## To mount the projector on a tripod

The projector includes standard tripod mount on the bottom of the projector. This allows the projector to be mounted on tripods readily available at camera and other electronic stores.



### CAUTION:

- The tripod should be capable of supporting a weight of at least 5 lb. Refer to the owner's manual that came with your tripod for more information.
- Do not overtighten the tripod mount screw. Doing so could strip the screw and cause the projector to fall off the tripod.

## To lock the projector

The projector includes a built-in slot to secure the projector with a cable and a lock (such as the Kensington MicroSaver lock system, available at many computer stores).

1. Wrap the cable around a secure object, such as a table leg. Loop the cable to create a slip knot around the stationary object, and be sure it cannot slip off.
2. Insert the lock ❶ into the hole and twist the key ❷.





---

## Fixing Problems

This chapter describes potential problems and offers suggestions to help correct them.

- “Troubleshooting Suggestions” on page 55
- “Testing the Projector” on page 63

### Troubleshooting Suggestions

To use this section, find the problem statement that is closest to your problem, then try each bulleted item one at a time until your problem is fixed. If the suggestions do not solve your problem, contact HP. See the *Support Guide* included with the projector.

- “Start-up problems” on page 56
- “Picture problems” on page 57
- “Sound problems” on page 61
- “Interruption problems” on page 61
- “Remote control problems” on page 62

## Start-up problems

### **If no lights or sounds turn on:**

- ❑ Be sure that the power cable is securely connected to the projector and the other end is plugged into an outlet with power.
- ❑ Press the power button again.

### **If nothing is projected but the projector seems to start up:**

- ❑ Be sure the lens cover is open.
- ❑ If the lamp indicator is on or blinking, unplug the projector after it cools down. Remove and reinstall the lamp module. If this does not fix the problem, install a new lamp.
- ❑ If the temperature indicator is on or blinking, turn off the projector and allow it to cool before restarting it. If the warning light turns on or blinks again, contact HP for assistance.

### **If the projector makes a “ticking” sound, if the projector lamp does not turn on, and if the lamp indicator is on or blinking:**

- ❑ The projector lamp is too hot to light. Turn off the projector and wait for it to cool before turning it on again.
- ❑ If the lamp indicator is on or blinking, unplug the projector after it cools down. Remove and reinstall the lamp module. If this does not fix the problem, install a new lamp.
- ❑ The projector lamp has reached the end of its life. Replace the lamp.



---

## Picture problems

**If the image is not displayed on the screen, but the HP startup screen is displayed:**

- ❑ Press the **source** button on the projector or remote control.
- ❑ Turn off or disable the notebook or desktop computer screen saver function.
- ❑ For a computer connection, ensure your notebook computer's external video port is turned on. See the video port card shipped with the projector. On some notebooks, for example, press the **Fn + F4** function keys to turn on the external video port.
- ❑ Verify that the right input source is connected. Open the on-screen menu and go to **Select input**. Then set the correct input port where the equipment is connected.
- ❑ Verify that auto search is enabled. Open the on-screen menu and go to **Select input > Auto-scan sources**.

**If the wrong input source is displayed:**

- ❑ Press the **source** button on the projector or the remote control to select another active input source.
- ❑ Verify that the right input source is connected. Open the on-screen menu and go to **Select input**. Then set the correct input source.
- ❑ Verify that the projector is enabled for auto-searching. Open the on-screen menu and go to **Select input > Auto-scan sources**.
- ❑ If the input source might turn off and on, open the on-screen menu and go to **Select input**. Set **Auto-scan sources** to **Off** and select the correct input source.

**If the image is out of focus:**

- ❑ Be sure the lens cover is open.
- ❑ While displaying the on-screen menu, adjust the focus ring. (The image size should not change; if it does, you are adjusting the zoom not the focus.)
- ❑ Ensure the projection screen is 1.2 to 12 m (4 to 40 ft) from the projector.
- ❑ For a computer connection, set the display resolution on the computer to 1024 x 768 pixels. If the computer has multiple monitors, adjust the resolution of the monitor assigned to the projector.
- ❑ Check the projection lens to see if it needs cleaning.

**If an upside-down or reversed image is displayed:**

- ❑ The projector has been set to the wrong position setting. Open the on-screen menu, select **Setup > Projector position**, and select the correct setting.

**If the image is too small or too large:**

- ❑ Adjust the zoom ring on top of the projector.
- ❑ Be sure the projector is 1.2 to 12 m (4 to 40 ft) from the projection screen.
- ❑ Open the on-screen menu and select **Adjust picture > Adjust picture mode > Aspect ratio**. Try the different settings.
- ❑ For a wide-screen picture, open the on-screen menu and select **Adjust picture > Shape settings** and try setting **Widescreen input** to **Yes**.

**If the image has slanted sides:**

- ❑ As much as possible, reposition the projector so that it is centered on the screen and below the bottom or above the top of the screen.
- ❑ Open the on-screen menu and select **Quick choice > Keystone**. Adjust the setting as needed.

**If a scrolling or cut-off image is displayed:**

- ❑ Press the **auto sync** button on the projector or remote control.
- ❑ For a computer connection, turn everything off, then power on the projector first and power on the notebook or desktop computer second.
- ❑ For a computer connection, if the above steps do not correct the display image, adjust the resolution of the notebook or desktop computer to 1024 x 768 pixels. If the computer has multiple monitors, adjust the resolution of the monitor assigned to the projector.

**If the image is flickering or unstable:**

- ❑ Press the **auto sync** button on the projector panel or remote control.
- ❑ For a computer connection, set the display resolution to 1024 x 768 pixels. If the computer has multiple monitors, adjust the resolution of the monitor assigned to the projector.
- ❑ For a computer connection, open the on-screen menu, select **Adjust picture > VGA settings** and adjust the **Frequency** or **Tracking**.

**If the image is stretched:**

- ❑ Open the on-screen menu and select **Adjust picture > Adjust picture mode > Aspect ratio**. Try the different settings.
- ❑ Open the on-screen menu and select **Adjust picture > Shape settings**. Try changing the **Widescreen input** setting.

**If the image disappears from the computer screen:**

- ❑ For a notebook computer, you might be able to turn on both the external VGA port and the built-in screen. See the computer manual or the projector's video port guide.

**If text or lines from a computer display seem rough or uneven:**

- ❑ Check the focus adjustment.
- ❑ Open the on-screen menu and select **Quick choice > Reset keystone**.

**If the projected colors seem slightly wrong:**

- ❑ If the video button on the projector is not lit, try pressing the video button on the projector or the picture mode button on the remote control.
- ❑ Open the on-screen menu and select **Adjust picture > Color settings**. Adjust the color settings as needed.
- ❑ Open the on-screen menu and select **Adjust picture > Color Settings > Color space**. Change the selection.
- ❑ Open the on-screen menu and select **Help > Diagnostics**. Run color tests.

**If the projected colors seem completely wrong:**

- ❑ Be sure the pins on the cable connectors are not bent or broken.
- ❑ Open the on-screen menu and select **Adjust picture > Color settings > Color space**. Change the selection.
- ❑ Open the on-screen menu and select **Help > Diagnostics**. Run color tests.
- ❑ Reset the picture settings to the factory-default settings. See the following problem.

**If the picture settings are completely wrong and you cannot fix them:**

- ❑ Reset the projection settings to the factory-default settings. To do this, open the on-screen menu and select **Setup > Reset all settings**, or hold down the down ▼ + up ▲ + right ➤ buttons on the projector for 5 seconds.

**If the projector stops responding to all controls:**

- ❑ If possible, turn off the projector, then unplug the power cord and wait at least 15 seconds before reconnecting power.

---

## Sound problems

### If no sound is coming out of the projector:

- ❑ Be sure you have an audio cable securely connected between the projector and the input device.
- ❑ Be sure that the mute and volume settings are correct on the input device, such as a computer, DVD player, or camcorder.
- ❑ Open the on-screen menu and select **Quick choice**. Check the following settings:
  - ◆ Mute is turned off.
  - ◆ Volume is correct.

## Interruption problems

### If the lamp indicator or temperature indicator turns on or blinks:

- ❑ If the lamp indicator blinks, the lamp is not able to light. Wait for the projector to cool, then try starting it again.
- ❑ If the lamp indicator is on or blinking, unplug the projector after it cools down. Remove and reinstall the lamp module. If this does not fix the problem, install a new lamp.
- ❑ If the temperature indicator turns on or blinks, the projector is too hot. See the following problem.

### If the projector suddenly shuts down and the temperature light turns on:

- ❑ If the temperature light is blinking, the fan is not working. Allow the projector to cool for several minutes.
- ❑ If the temperature light is steady, the projector has overheated. Allow it to cool for several minutes.
- ❑ If airflow is obstructed, remove the obstruction.
- ❑ If possible, remove any sources of excess heat in the room.
- ❑ If the condition occurs after restarting the projector, contact HP to have the projector serviced or repaired.

**If the lamp shuts off during a presentation:**

- ❑ A minor power surge might cause the lamp to shut off. Wait a few minutes, then power on the projector.
- ❑ If the lamp indicator is on or blinking, unplug the projector after it cools down. Remove and reinstall the lamp module. If this does not fix the problem, install a new lamp.

**If the lamp burns out or makes a popping sound:**

- ❑ If the lamp burns out and makes a popping sound, the projector will not turn back on until the lamp module has been replaced.
- ❑ If the lamp breaks, contact HP about repairs that might be required.

## Remote control problems

**If the remote control does not operate:**

- ❑ Be sure nothing is blocking the remote control receiver on the front or back of the projector. Move to within 9 m (30 ft) of the projector.
- ❑ Open the on-screen menu and select **Help > Diagnostics**. Run remote control test.
- ❑ Replace the battery in the remote control.

**If only the mouse and page-up and page-down buttons do not work:**

- ❑ Be sure you have a USB connection between the projector and the computer.
- ❑ Open the on-screen menu and select **Help > Diagnostics**. Run remote control test and USB test.

## Testing the Projector

The on-screen menu contains diagnostic tests you can use to verify the proper operation of the projector and the remote control.

### To run the projector diagnostics

1. Open the on-screen menu and select **Help > Diagnostics**.
2. Select a test to perform.





This chapter lists the specifications, safety information, and regulatory information for the projector.

- “Specifications” on page 65
- “Safety Information” on page 70
- “Regulatory Information” on page 72

## Specifications

Because HP continually improves its products, the following specifications are subject to change. For the latest specifications, visit the HP website at <http://www.hp.com>.

### Identifying the projector specifications

|                     |   |
|---------------------|---|
| Size                | 251 mm × 210 mm × 69 mm<br>(9.9 in. × 8.3 in. × 2.7 in.)  |
| Weight              | 1.8 kg (3.9 lb)   |
| Resolution          | XGA   |
| Technology          | DLP   |
| Video connectors    | VGA input, S-video input, composite-video input (RCA)<br>Optional cable for component-video input                     |
| Audio connectors    | Mini-phone stereo audio input   |
| Video compatibility | NTSC M (3.58 MHz), 4.43 MHz; PAL B, D, G, H, I, M, N;<br>SECAM B, D, G, K, K1, L; HDTV 480i/p, 575i/p, 720p,<br>1080i |
| IR receivers        | On front and back of projector  |

**Identifying the projector specifications *(continued)***

|                  |  |
|------------------|--|
| Lens             | 2.0 to 2.4 throw ratio (distance/width)  |
| Optical zoom     | 1:1.2  |
| Keystone         | Manual correction: up to +25° to -30° vertical   |
| Audio            | Monaural speaker, 1-W peak output  |
| Lamp             | 200-W P-VIP lamp, 1.0-mm arc<br>2000 hours (half life)<br>Lamp-saver mode reduces lamp power to 160 W, extends lamp life<br>Replacement lamp: L2152A |
| Light engine     | 0.7-in. 12° DDR DMD<br>XGA   |
| Color system     | Two preset color modes are available:<br>Graphics<br>Video   |
| Remote control   | USB mouse  |
| Mounting options | Ceiling and tabletop, front and rear projection  |
| Security         | Kensington lock compatible   |
| Power            | 100 to 240 V at 50 to 60 Hz  |

---

**Identifying the projector specifications *(continued)***

---

Noise level 38±2 dBA

---

Environment

**Operating:**

Temperature: 10 to 35°C (50 to 95°F)

Humidity: 80% RH max, non-condensing

Altitude: up to 3,000 m (10,000 ft), up to 25°C (77°F)

**Storage:**

Temperature: -20 to 55°C (-4 to 131°F)

Humidity: 80% RH max, non-condensing

Altitude: up to 12,000 m (40,000 ft)

---

**Analog Video Mode Compatibility**

| <b>Compatibility</b> | <b>Resolution</b> | <b>V-Sync (Hz)</b> | <b>H-Sync (kHz)</b> |
|----------------------|-------------------|--------------------|---------------------|
| VGA                  | 640 x 350         | 70                 | 31.5                |
|                      | 640 x 350         | 85                 | 37.9                |
|                      | 640 x 400         | 85                 | 37.9                |
|                      | 640 x 480         | 60                 | 31.5                |
|                      | 640 x 480         | 72                 | 37.9                |
|                      | 640 x 480         | 75                 | 37.5                |
|                      | 640 x 480         | 85                 | 43.3                |
|                      | 720 x 400         | 70                 | 31.5                |
|                      | 720 x 400         | 85                 | 37.9                |
| SVGA                 | 800 x 600         | 56                 | 35.2                |
|                      | 800 x 600         | 60                 | 37.9                |
|                      | 800 x 600         | 72                 | 48.1                |
|                      | 800 x 600         | 75                 | 46.9                |
|                      | 800 x 600         | 85                 | 53.7                |
| XGA                  | 1024 x 768        | 60                 | 48.4                |
|                      | 1024 x 768        | 70                 | 56.5                |
|                      | 1024 x 768        | 75                 | 60.0                |
|                      | 1024 x 768        | 85                 | 68.7                |
| SXGA                 | 1280 x 1024       | 60                 | 63.98               |
|                      | 1280 x 1024       | 75                 | 79.98               |
| SXGA+                | 1400 x 1050       | 60                 | 65.22               |
|                      | 1400 x 1050       | 60                 | 63.98               |
| MAC LC 13            | 640 x 480         | 66.66              | 34.98               |

**Analog Video Mode Compatibility (continued)**

| <b>Compatibility</b> | <b>Resolution</b> | <b>V-Sync (Hz)</b> | <b>H-Sync (kHz)</b> |
|----------------------|-------------------|--------------------|---------------------|
| MAC II 13            | 640 x 480         | 66.68              | 35                  |
| MAC 16               | 832 x 624         | 74.55              | 49.725              |
| MAC 19               | 1024 x 768        | 75                 | 60.24               |
| MAC                  | 1152 x 870        | 75.06              | 68.68               |
| MAC G4               | 640 x 480         | 60                 | 31.35               |
| MAC G4               | 640 x 480         | 120                | 68.03               |
| MAC G4               | 1024 x 768        | 120                | 97.09               |
| i Mac DV             | 640 x 480         | 117                | 60                  |
| i Mac DV             | 800 x 600         | 95                 | 60                  |
| i Mac DV             | 1024 x 768        | 75                 | 60                  |
| i Mac DV             | 1152 x 870        | 75                 | 68.49               |
| i Mac DV             | 1280 x 960        | 75                 | 75                  |
| i Mac DV             | 1280 x 1024       | 75                 | 90.9                |

## Safety Information

### Safety precautions

---



**WARNING:** Observe the following precautions to reduce the risk of injury.

---

- To prevent eye injury, do not look directly into the lens when the lamp is on.
- To prevent electrical shock, do not expose the projector to rain or moisture. Do not open the projector except as instructed by the manual.
- To reduce the risk of fire or electrical shock, do not allow small metallic objects to get inside the projector. Carry the projector only in its protective case, and do not store paper clips or other small objects inside the case.
- Allow the projector to cool before removing any cover and touching internal components, as instructed by the manual.
- Keep paper and other combustible material away from the projector lens to prevent the possibility of fire.
- Use only an approved power cord rated for the voltage and current marked on the product label. Do not overload any outlet or extension cord.

## LED safety

The infrared ports located on the digital projector and remote control are classified as Class 1 LED devices according to International Standard IEC 825-1 (EN60825-1). This device is not considered harmful, but the following precautions are recommended:

- If the unit requires service, contact an authorized HP service center.
- Do not attempt to make any adjustment to the unit.
- Avoid direct eye exposure to the infrared LED beam. Be aware that the beam is invisible light and cannot be seen.
- Do not attempt to view the infrared LED beam with any type of optical device.

## Mercury safety



**WARNING:** This digital projector lamp contains a small amount of mercury. If the lamp breaks, adequately ventilate the area where the breakage occurred, discard any nearby food and drink, and thoroughly clean the table surface around the projector. Wash your hands after cleaning the area or handling a broken lamp. Disposal of this lamp may be regulated due to environmental considerations. For disposal or recycling information, please contact your local authorities or the Electronic Industries Alliance ([www.eiae.org](http://www.eiae.org)). You can find safety information about the lamp at [www.hp.com/hpinfo/globalcitizenship/environment/productdata](http://www.hp.com/hpinfo/globalcitizenship/environment/productdata).

---

## Regulatory Information

This section presents information that shows how your digital projector complies with regulations in certain regions. Any modifications to your digital projector not expressly approved by HP could void the authority to operate the digital projector in these regions.

### U.S.A.

This digital projector has been tested and found to comply with the limits for a Class B digital device, pursuant to Part 15 of the FCC Rules. These limits are designed to provide reasonable protection against harmful interference in a residential installation.

This digital projector generates, uses, and can radiate radio frequency energy. If not installed and used in accordance with the instructions, it can cause harmful interference to radio communications. However, there is no guarantee that interference will not occur in a particular installation. If this digital projector does cause harmful interference to radio or television reception (which can be determined by unplugging the unit), try the following:

- Reorienting or relocating the receiving antenna.
- Relocating the digital projector with respect to the receiver.
- Connecting the digital projector's power cord to another power outlet.

### Connections to peripheral devices

To maintain compliance with FCC Rules and Regulations, use properly shielded cables with this device.

For more information, consult your dealer, an experienced radio/television technician, or, prepared by the Federal Communications Commission, *How to Identify and Resolve Radio-TV Interference Problems*. This booklet is available from the U.S. Government Printing Office, Washington, DC 20402, Stock Number 004-000-00345-4. At the first printing of this manual, the telephone number was 202-512-1800.

### Canada

This Class B digital apparatus complies with Canadian ICES-003.



## Japan

この装置は、情報処理装置等電波障害自主規制協議会（VCCI）の基準に基づくクラスB情報技術装置です。この装置は、家庭環境で使用することを目的としていますが、この装置がラジオやテレビジョン受信機に近接して使用されると受信障害を引き起こすことがあります。

取り扱い説明書に従って正しい取り扱いをして下さい。

## Korea

사용자 안내문 : **B** 급 기기

이 기기는 비업무용으로 전자파적합등록을 받은 기기이오니, 주거지역에서는 물론, 모든 지역에서 사용 하실 수 있습니다.

## International

For regulatory identification purposes, your product is assigned a regulatory model number. The regulatory model number for your product is listed in the declaration of conformity. This regulatory number is different from the marketing name and product number.

### DECLARATION OF CONFORMITY

According to ISO/IEC Guide 22 and EN 45014

**Manufacturer's Name:** Hewlett Packard Company  
**Manufacturer's Address:** Display Technologies & Products  
 1000 NE Circle Blvd.  
 Corvallis, OR 97330-4239

Declares, that the product(s):

**Product Name:** Digital Projector  
**Model Number(s):** mp3320, mp3322 series  
**Regulatory Model:** CRVSB-04VU

**Conforms to the following product specifications:**

**Safety:** IEC 60950-1:2001/ EN 60950-1:2001 +A11:2004

IEC 60825-1:1993 +A1 / EN 60825-1:1994 +A11 Class 1 LED

GB4943-1995

**EMC:** AS/NZS CISPR22: 2002

EN55022: 1998+ A1: 2000+ A2: 2003 Class B

EN55024: 1998+ A1: 2001+ A2: 2003

EN61000-3-2: 2000

EN61000-3-3: 1995+ A1: 2001

FCC - 47 CFR Part 15, subpart B, Class B

ANSI C63.4 – 2003

ICES – 003: 2004

GB9254 – 1998, GB17625.1 - 2003

**Supplementary information:**

The product herewith complies with the requirements of following Directives and carries the CE marking accordingly:

-Low Voltage Directive: 73/23/EEC

-EMC Directive: 89/336/EEC

[1] The product was tested in a typical configuration with Hewlett Packard Personal Computer peripherals.

This device complies with Part 15 of the FCC Rules. Operation is subject to the following two conditions:

(1) this device may not cause harmful interference, and (2) this device must accept any interference received, including interference that may cause undesired operation.

Corvallis, Oregon, December 7, 2005

CE



Steve Brown, General Manager

European Contact for regulatory topics only: Hewlett Packard GmbH, HQ-TRE, Herrenberger Straße 140, 71034 Boeblingen, Germany. (FAX:+49-7031-143143).

USA Contact: Hewlett Packard Co., Corporate Product Regulations Manager, 3000 Hanover Street, Palo Alto, CA 94304. Phone: (650) 857-1501.





## A

- accessories
  - listing 14
- adjust picture 34
- aiming the projector
  - raising and lowering 26
- analog video mode
  - compatibility 68
- audio
  - adjusting 34

## B

- back panel
  - identifying 12
- buttons
  - projector 11
  - remote control 13

## C

- ceiling installation
  - setting up 50
- component video connection
  - connecting video source 23
- composite video connection
  - connecting video source 22
- configuration
  - using on-screen menu 37
- connecting input sources
  - component video connection 23
  - composite video connection 22
  - computer with VGA port 19
  - handheld organizer 20

- with S-video 21

- contents
  - in the box 8

## D

- dimensions
  - of screen and room 16
- distance
  - setting up in relation to image 15

## F

- firmware
  - updating 47
- focus
  - adjusting 27
  - range of 27

## G

- graphics mode
  - see* picture mode

## H

- handheld organizer
  - connecting 20
- hide button
  - using 32

## I

- image
  - adjusting 34
- input/output connectors
  - see* back panel
- installation

*see* ceiling installation  
*see* rear projection installation  
*see* table installation

**K**

Kensington lock 53  
keystone correction  
    adjusting 33

**L**

lamp module  
    replacing 44  
lamp saver mode 35  
language  
    changing 35  
LED safety  
    precautions 71  
lens  
    care 44  
    cleaning 44  
lights  
    identifying 11  
location  
    *see* ceiling installation  
    *see* rear projection installation  
    *see* table installation

lock 53

**M**

maintenance  
    routine maintenance 43  
menu  
    *see* on-screen menu

**O**

on-screen menu  
    about menu definitions 42  
    adjust picture menu definitions 40  
    quick choice menu definitions 38  
    select input menu definitions 39  
    setup menu definitions 42

    using 36, 37  
optimizing image 34

**P**

picture  
    adjusting 34  
picture mode  
    changing 30, 34  
    definition 34  
power  
    turning off 25  
    turning on 24  
presentations  
    changing source 32  
    from a computer 31  
projector  
    adjusting 33  
    identifying parts 10  
    maintaining 43  
    setting up 15  
    troubleshooting 55  
    upgrading 47

**R**

rear panel  
    *see* back panel  
rear projection installation  
    setting up 52  
remote control  
    battery replacement 46  
    identifying 13  
    using 29  
reset 60  
resetting  
    projection settings 60  
    projector 60

**S**

safety information  
    LED 71

---

- precautions 70
- SCART device 21
- security
  - locking 53
- setup
  - adjusting 35
  - see also* ceiling installation
  - see also* rear projection
  - see also* table installation
- slanted picture
  - see* keystone correction
- sound
  - see* audio
- source
  - changing 32
- specifications
  - of the projector 65
- status
  - of projector 43
- S-video connection
  - connecting video source 21

**T**

- table installation
  - setting up 17

- testing
  - diagnostics 63
- tripod
  - mounting on 53
- troubleshooting
  - interruption problems 61
  - picture problems 57
  - remote control problems 62
  - sound problems 61
  - start-up problems 56
  - suggestions 55
- turning off 25
- turning on 24

**U**

- upgrading 47

**V**

- video mode
  - see* picture mode
- video sources 21

**Z**

- zoom
  - adjusting 27
  - range of 27

